

Vigilon Plus Control Panels

Vigilon Plus Control Panels are available in 3 sizes managing 2, 4 or 6 loops each accommodating up to 200 devices including advanced fire sensors, interfaces, call points, alarm sounders and visual alarms.

The Compact Plus 2 loop panels and Vigilon Plus 4 loop panels are available with integrated 24 hour standby and the 6 loop panel has full 72 hr standby capacity. Advanced networking options allow networking of up to 200 panels in a multi-domain structure with options of copper or optic fibre connections.

Vigilon's back-lit LCD display presents clear indication of Fire or Fault location and the control panel's innovative 8-line x 40 character display with push-button keypad is simple to use. Fire Plans can be tailored to precisely meet site requirements.

Vigilon's software allows network areas to be sectorised to evacuate or alert status, or configured with pre-set delays.

Fully compatible with Honeywell Gent's innovative S-Quad range – a combined Multi-Sensor range with speech, sounder and EN54-23 Visual Alarm devices in one intelligent unit.

The Vigilon Plus Repeat control panel provides full display and control of the system. Connecting to the detection loop, the repeat panel provides a cost effective solution with minimum requirements for cabling and installation.

Repeat panels are supplied complete with their own 72 hour power supply and standby batteries.



Description

The Vigilon Plus Range of Advanced Fire Detection Control Panels is applicable for buildings of any size.

KEY FEATURES

- Integral EN54-4 PSU and battery standby for 24 hours (4 loop)
- Integral EN54-4 PSU for 72 hours with external batteries (6 loop)
- Vigilon's advanced sensing technology and powerful software processing in the panel quickly identifies real fires
- PC based commissioning tools allow complex fire plans to be configured
- Advanced loop card technology allows for system status monitoring and diagnostics
- Vigilon Plus can also be supplied in a range of custom colour outer doors
- The control panel has a simple user interface with LCD screen providing accurate information in an emergency
- Multiple panel networks can be programmed seamlessly as one system, allowing for flexible design and system management
- Flexible programming options are available at the panel
- All Vigilon devices connect onto the same two core loop, separate sounder or repeater panel wiring circuits are not required
- In the event of a fire or fault, Vigilon's analogue addressable technology will provide a detailed log of events
- PC based Graphics user interface (GUI) available
- Extended event log using flash memory card

Vigilon Plus Control Panels Technical Specifications

ORDER CODES

1 TO 2 LOOP CONTROL PANEL	COMPACTPLUS-24
1 TO 4 LOOP CONTROL PANEL	VIGPLUS-24
1 TO 4 LOOP CONTROL PANEL - NO PRINTER	VIGPLUS-24-NP
1 TO 6 LOOP CONTROL PANEL	VIGPLUS-72
VIGILON LOOP CARD	VIG-LPC-EN
VIGILON NETWORK CARD (COPPER)	VIG-NC
VIGILON NETWORK CARD (MULTIMODE FIBRE)	VIG-NC-FO
VIGILON UPGRADE KIT	VIG72-UPGR
FLUSH SURROUND	VIG-FLUSH
VIGILON PLUS REPEAT PANEL	VIGPLUS-RPT
STAINLESS STEEL OPTIONS	
STAINLESS STEEL DOOR FOR VIGILON MAIN CONTROL PANEL	VIG-DOOR-SS
STAINLESS STEEL FLUSH MOUNTING KIT FOR VIGILON MAIN CONTROL PANEL	VIG-FLUSH-SS
CUSTOM COLOUR DOOR	Contact Business Manager

SPECIFICATION

PANEL TYPE	Compact Plus 2 Loop	Vigilon Plus 4 Loop Panel	Vigilon Plus 6 loop panel	Vigilon Plus Repeat Panel
MAX. NO. OF LOOPS	2	4	6	-
LOOP CAPACITY	200 with Alarm Current 800mA (Max Alarm current across both loops (1.2 A))	200 with an alarm current of up to 800mA (Equivalent to 100 sensor sounders VADs)	200 with an alarm current of up to 800mA (Equivalent to 100 sensor sounders VADs)	Max 4 per loop
BATTERIES	2 x 12Ah	2 x 21Ah	4 or 8 x 21Ah	1 x 7Ah
BATTERY STANDBY	24hrs +30 mins in alarm	24 hours + 30 minutes alarm upgradeable to 72 hours	72 hours + 30 minutes alarm	72 hours
APPROX. WEIGHT	12 Kg (inc batteries)	22 Kg (inc batteries)	10.2 Kg (panel only) 31 Kg (battery enclosure inc four batteries)	9Kg (inc batteries)
OPERATING TEMP.	0-45°C	0-45°C	0-45°C	0-45°C
CABLE ENTRY	Top and rear knockins			
APPROVALS	EN54 Parts 2 & 4			

EN54-2 requires that Vigilon 4 & 6 loop panels are restricted to max. 512 sensors and call points

Dimensions (mm)

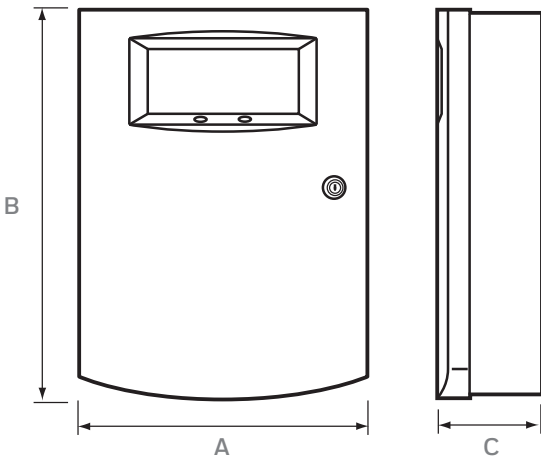

	A	B	C
Vigilon Plus	406	543	172
Battery Box (only required with VIG1-72 6 loop panel)	421	437	174
Compact Plus / Vigilon Plus Repeat Panel	338	403	101

For more information

www.gent.co.uk

Honeywell Gent

140 Waterside Road
Hamilton Industrial Park,
Leicester, LE5 1TN
Telephone: 0116 246 2042
E-mail: gentenquiry@honeywell.com

System Architecture

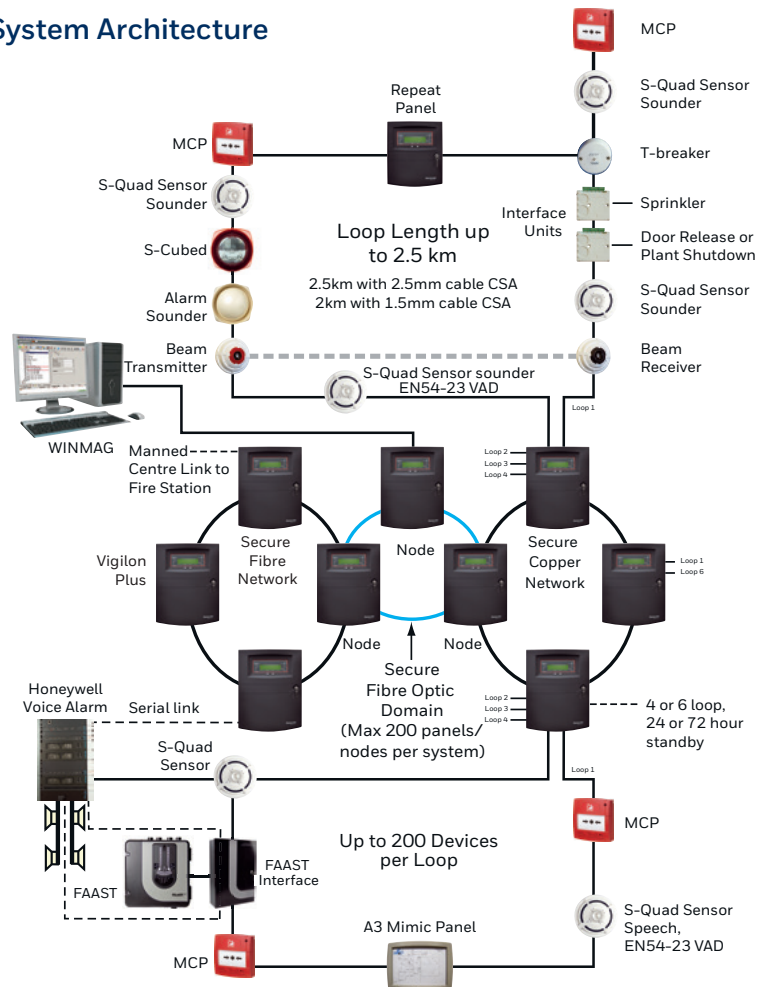

Content subject to change without notice.

GEN147 | 03/2017
© 2017 Honeywell International Inc.

Honeywell
GENT